

P/N: FAPE201042

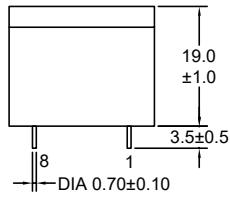

Outline Dimensions(Unit:mm)



Front View

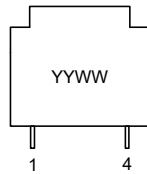

Side View



Bottom View

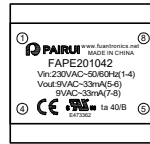

Top View

Note:

- 1.Remove Pins 2,3.

Wave Soldering



- Note:
- 1.Never Contact the ceramic with the iron tip;
 - 2.1.0mm tip diameter(max).

Electronical Schematic

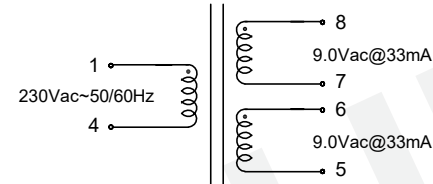

Electrical Characteristics

- Input 230Vac 50Hz to 1-4 :
- Excitation current(Ix):15mA Max.
 - Output: Vo(5-6)=14.5Vac Max.
 - Vo(7-8)=14.5Vac Max.
 - VL(5-8 short6,7)=18.0Vac±5%(Series @33mA).
 - VL(5,7-6,8)=9.0Vac±5%(Parallel@66mA).
 - Insulation Resistance: Pri-Sec: 100 Mohms Min @500V.
 - Hi-Pot: Pri-Sec: 4000VAC/5mA/60Second.

General Properties

- Operating Temperature:-25°C to +40°C.
- Storage Temperature:-25°C to +85°C.
- Insulation Class: B.

				Tianchang Fuan Electronic Co Ltd www.fuantronics.net TEL: +86-550-7814888 FAX: +86-550-7831133		Make: Qiumei.Liu Checked: Beson. zhan Approved: Anson. zhan	DRAWING TITLE 0.60W Encapsulated Transformer For EE20*10,230VAC Input 50/60Hz Material Number: A222010XS310	Customer Name: Document/Rev: 00 Specification Sheet: 1 of 3 Date of Recognition: Jan./02/2020
REV	DESCRIPTION	APPD	DATE		Tolerances unless otherwise specified: (.X)±0.50 (XX)±0.25 Unit of measurement: mm			

P/N: FAPE201042



List of UL Certificate:

No.	Part Name	Mat'l Description	Supplier	UL Number
1	Bobbin	EE20*10/PBT(Black)	Chang Chun Plastics Co Ltd	E59481
2	Case	CASE-EE20*10/PA66(Orange)	Zhejiang Juner New Materials Co Ltd	E204321
3	Copper wire	2UEW-F/155C	Elektrisola Hangzhou Co Ltd	E258243
4	Core	Lamination(Z11)	Ta Yea Steel Industry Co Ltd	N/A
5	Epoxy	PU552(Black)	Wevo-Chemle Gmbh	E108835
6				

Packaging Specification:

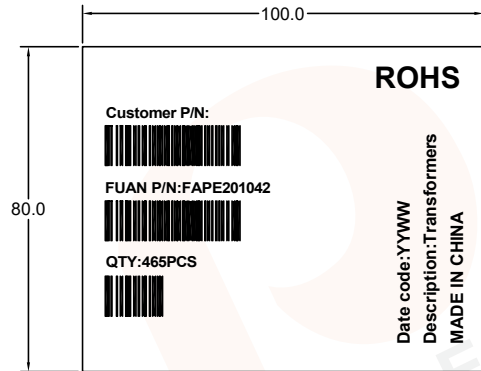

Label of outer

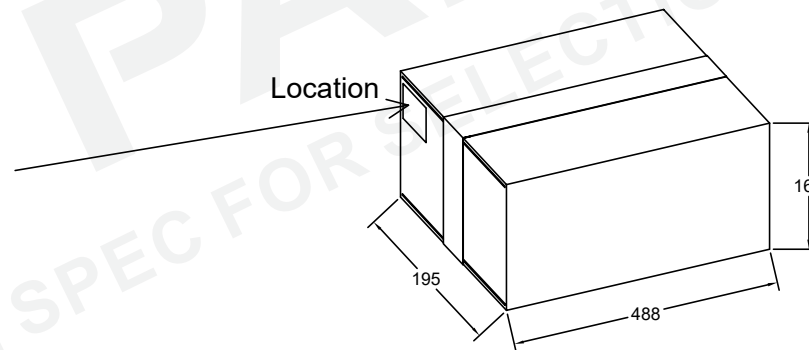

put the label on the top left corner of one of the carton sides

				Tianchang Fuan Electronic Co Ltd www.fuantronics.net TEL: +86-550-7814888 FAX: +86-550-7831133	 Tolerances unless otherwise specified: (.X)±0.50 (XX)±0.25 Unit of measurement: mm	Make: Qiumei.Liu Checked: Beson. zhan Approved: Anson. zhan	DRAWING TITLE 0.60W Encapsulated Transformer For EE20*10,230VAC Input 50/60Hz Material Number: A222010XS310	Customer Name: Document/Rev: 00 Specification Sheet: 2 of 3 Date of Recognition: Jan./02/2020
REV	DESCRIPTION	APPD	DATE					

P/N: FAPE201042



Packing Method:

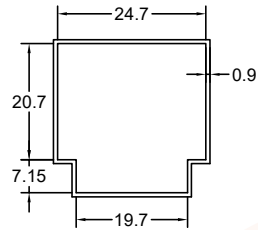
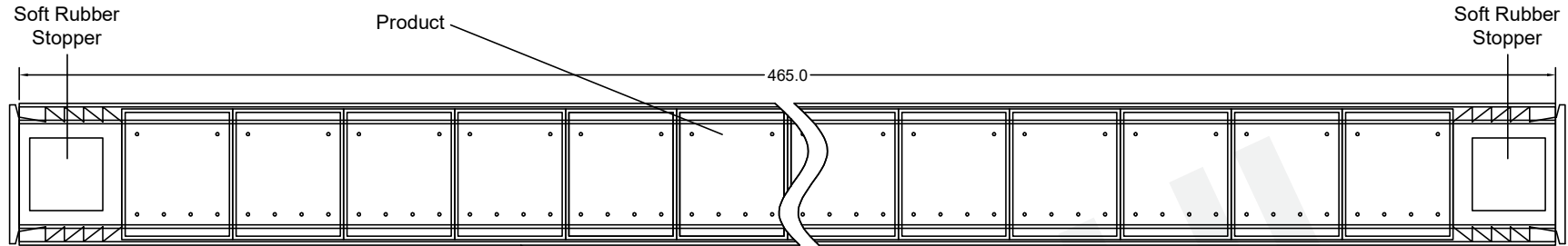

Size of packaging tube:
460mm*26.5mm*29.7mm
(Length * Width * Height)

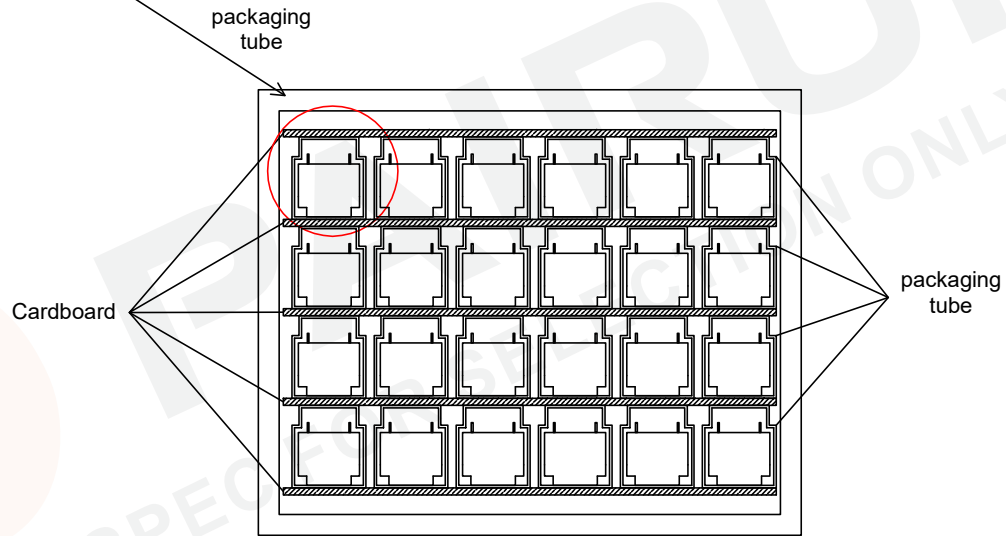

Carton Box Side View

Layer/Carton	Quantity/Tube (pcs)	Quantity/Carton (pcs)	Net weight (g/pc)	Gross weight (g/tube)	Tubes/carton (pcs)	Total weight (kg)	box size Dimensions (mm)
4.0	24.0	456.0	14.8	70.58	19.00	9.12	488*195*160

REV	DESCRIPTION	APPD	DATE

Tianchang Fuan Electronic Co Ltd
www.fuantronics.net
TEL: +86-550-7814888
FAX: +86-550-7831133



Tolerances unless otherwise specified:
(.X)±0.50 (XX)±0.25
Unit of measurement: mm

Make: Qiumei.Liu
Checked: Beson. zhan
Approved: Anson. zhan

DRAWING TITLE
0.60W Encapsulated Transformer
For EE20*10,230VAC Input 50/60Hz
Material Number: A222010XS310

Customer Name:
Document/Rev: 00
Specification Sheet: 3 of 3
Date of Recognition: Jan./02/2020